

MEASURES

DIMENSIONS H x W x D	793x500x546 mm
GROSS/NET WEIGHT	125/102 kg
FIREWOOD ENTRANCE	432x337 mm
SMOKE FLUE	Ø 150-153 mm Top
EXTERNAL AIR INTAKE	Ø 80 mm

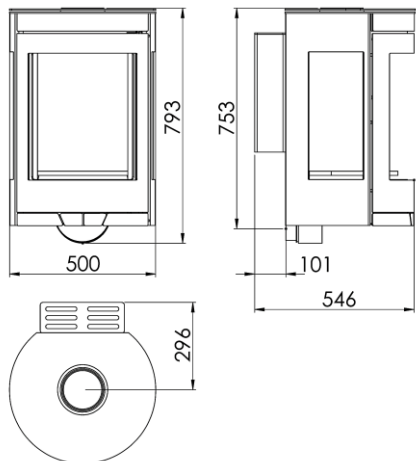





CHARACTERISTICS

CAST IRON GRILL	
THREE-SIDED VISION	
STEEL BODY SHEET	5 mm
NOMINAL HEAT OUTPUT	8 KW
EFFICIENCY	78,5 %
CO EMISSIONS	0,10 %
HEAT RESISTANT PAINT	800°C
CERAMIC GLASS HEAT RESISTANCE	750°C



PRODUCT PLUS

ECODESIGN

-  EXTERNAL AIR INTAKE
-  VERMICULITE LINING
-  WOOD LOGS 50 CM
-  240 m³ HEATING VOLUME
-  CLEAN GLASS SYSTEM
-  TRIPLE COMBUSTION
-  DOUBLE LOCK



EAN 8426964241051
REF. 24105



LINZ WALL EN

LINZ WALL EcoDesign



BlmSchV2

